

Bryant Headboard

Stock # BH17-084-099-53

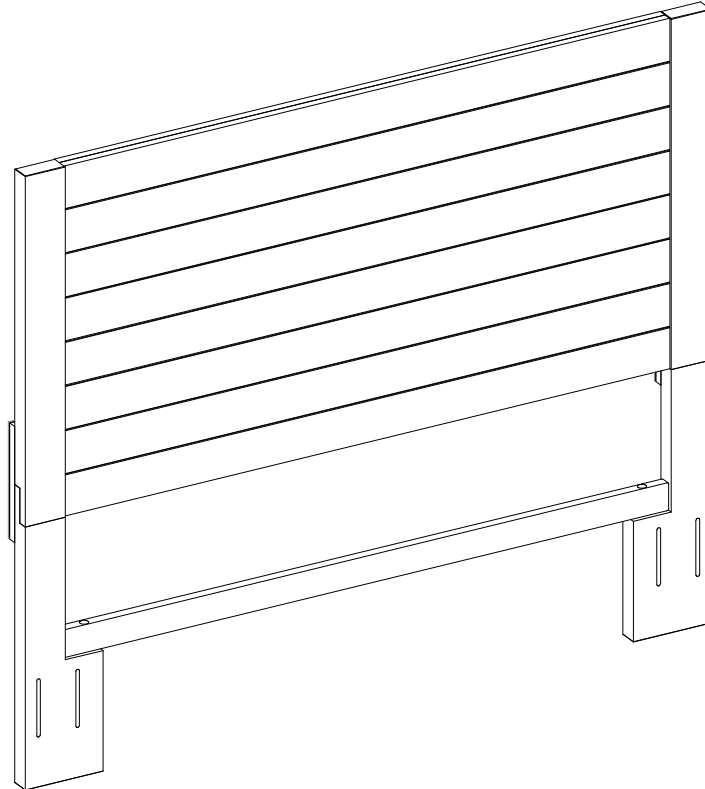

ADULT ASSEMBLY REQUIRED

If you have any questions regarding assembly or if parts are missing, DO NOT return this item to the store where it was purchased. Please call our customer service number and have your instructions and parts list ready to provide the model name, part name or factory number:

866-942-5362

Pacific Standard Time: 8:30 a.m. - 4:30 p.m., Monday - Friday

Or visit our web site 24 hours a day, 7 days a week for product assistance at

www.whalenstyle.com

Or e-mail your request to **parts@whalenfurniture.com**

**THIS INSTRUCTION BOOKLET CONTAINS IMPORTANT SAFETY INFORMATION.
PLEASE READ AND KEEP FOR FUTURE REFERENCE.**

Date 2017-05-18 Rev. 0001-A Factory: ZHIVIE

Parts and Hardware List

Please read completely through the instructions and verify that all listed parts and hardware are present before beginning assembly.

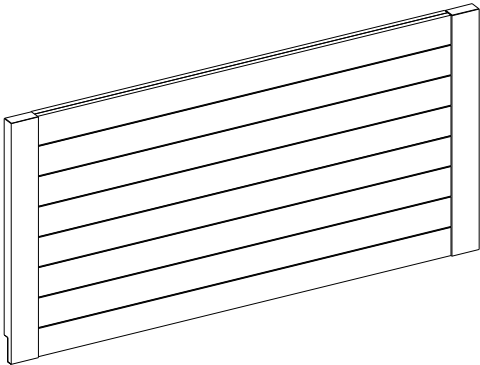

A- Headboard (Qty. 1)

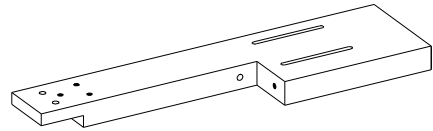

B- Left Leg (Qty. 1)

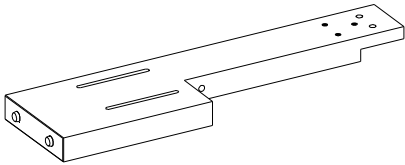

C- Right Leg (Qty. 1)

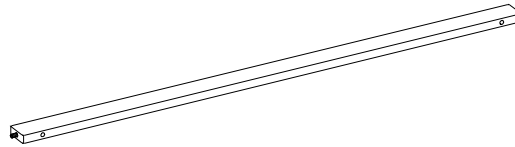

D- Bottom Stretcher (Qty. 1)



E- Back Support (Qty. 2)

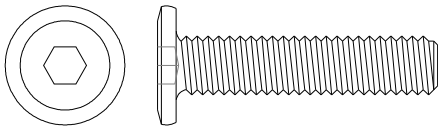

(1) 5/16" x 1-3/8" Bolt (Qty. 16+1 extra)
(4 pcs pre-attached)

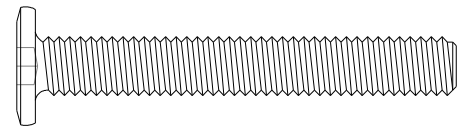

(2) 5/16" x 2-1/4" Bolt (Qty. 2+1 extra)

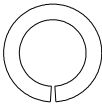

(3) Lock Washer (Qty. 26+1 extra)
(4 pcs pre-attached)

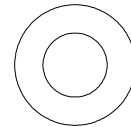

(4) Flat Washer (Qty. 26+1 extra)
(4 pcs Pre-attached)

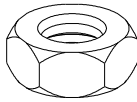

(5) Hex Nut (Qty. 4+1 extra)

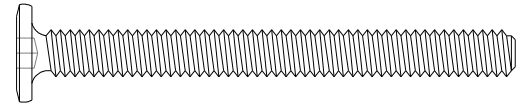

(6) 1/4" x 2-1/2" Bolt (Qty. 4+1 extra)



Open Wrench (Qty. 1)

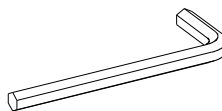

Hex Wrench (Qty. 1)

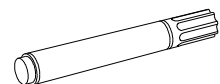

Touch-up Pen (Qty. 1)

Tools required: Open wrench and hex wrench (provided).

Assembly Instructions

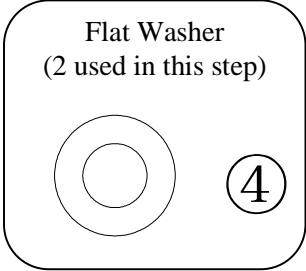
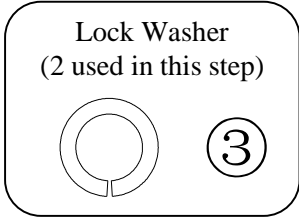
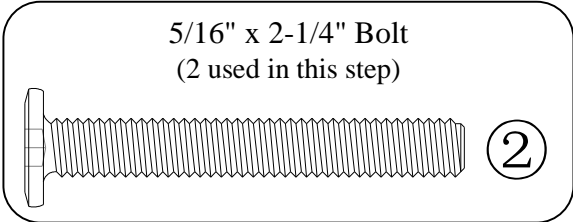
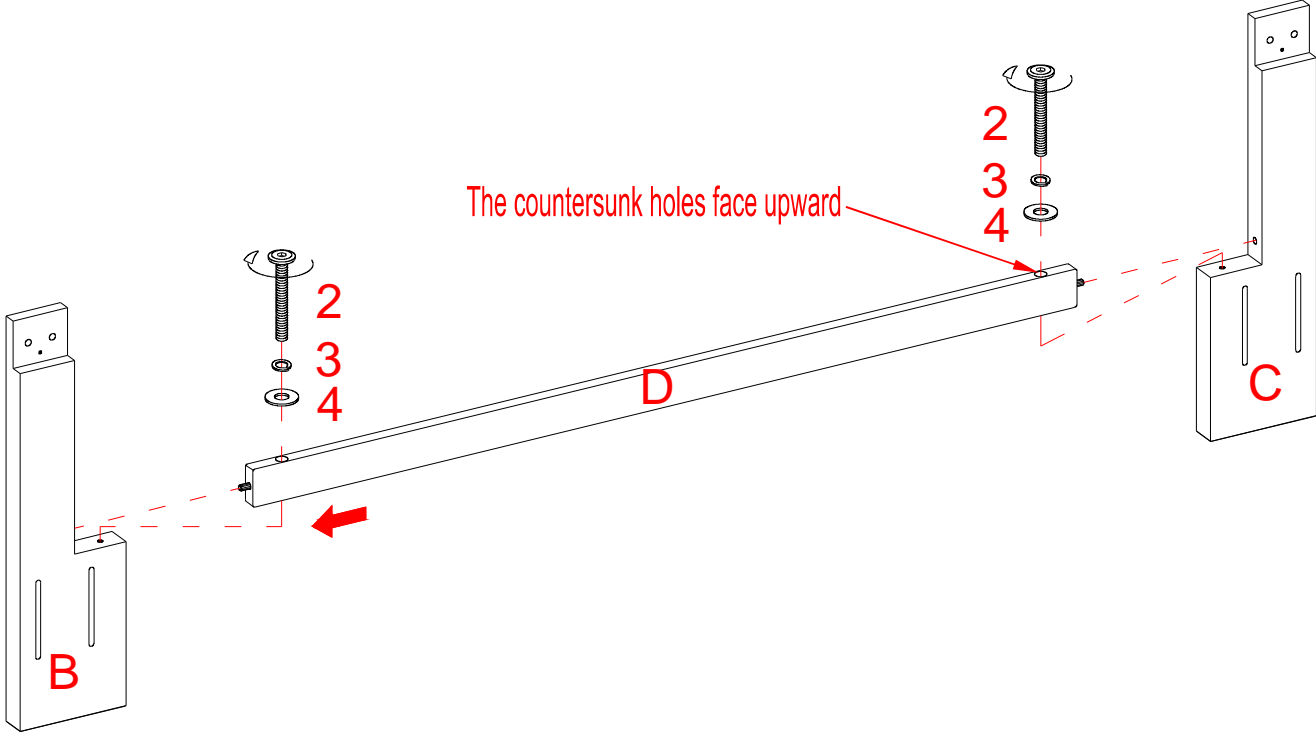

1. Unpack the units and confirm that you have all hardware and required parts.
2. Fasten the Bottom Stretcher (D) between the Legs (B and C) with two 2-1/4" Bolt (2) and two Washers (3 and 4).

Assembly Instructions

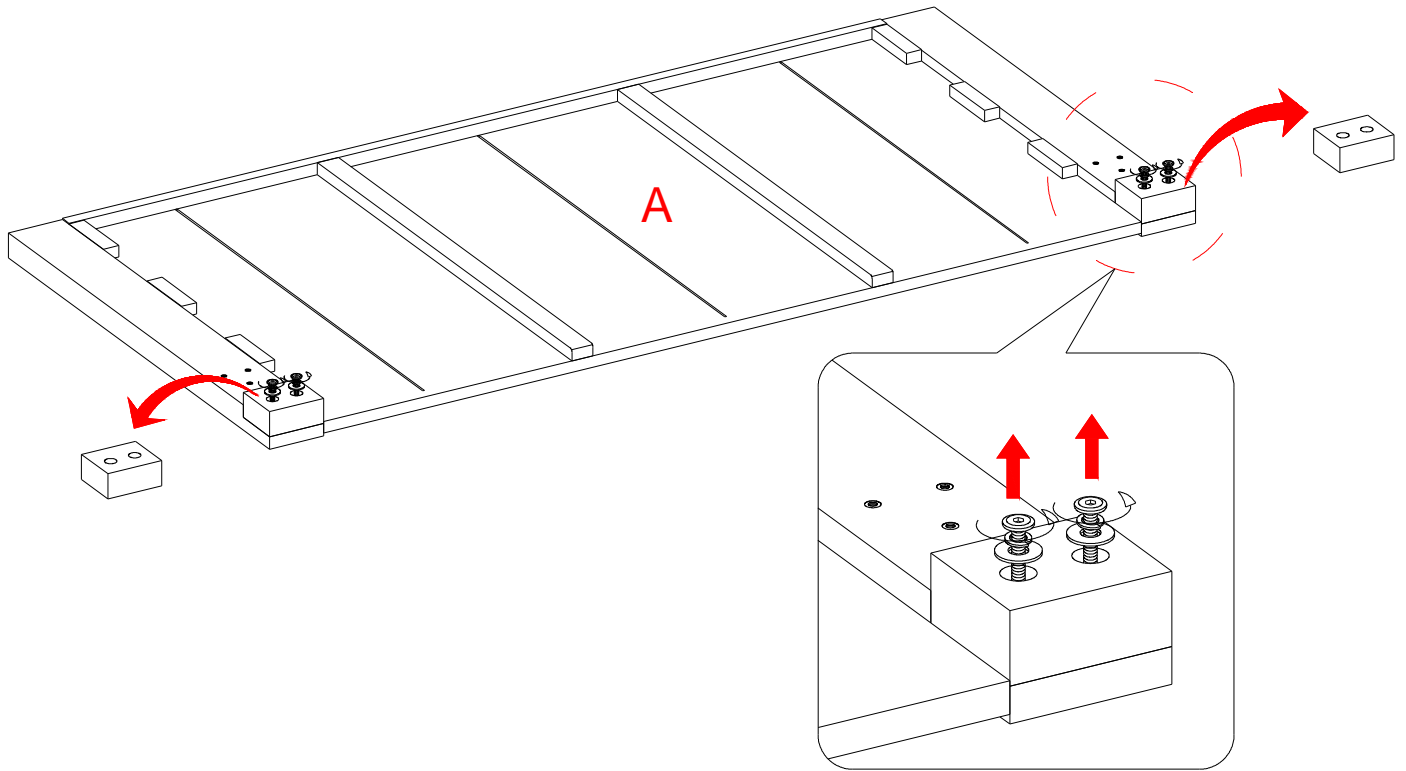

3. Position the Headboard (A) and set the front face down on a level and protective surface.
4. Remove the additional wood blocks from the Headboard (A) by unscrewing four 1-3/8" Bolts (1) and four Washers (3 and 4). Set the unscrewed bolts and washers aside for later use. The wood blocks are used for shipping purposes only. After removing them, please discard.

Assembly Instructions

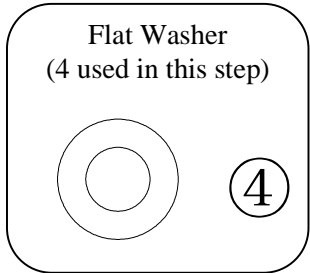
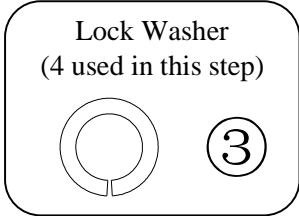
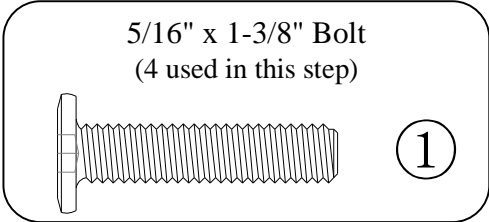
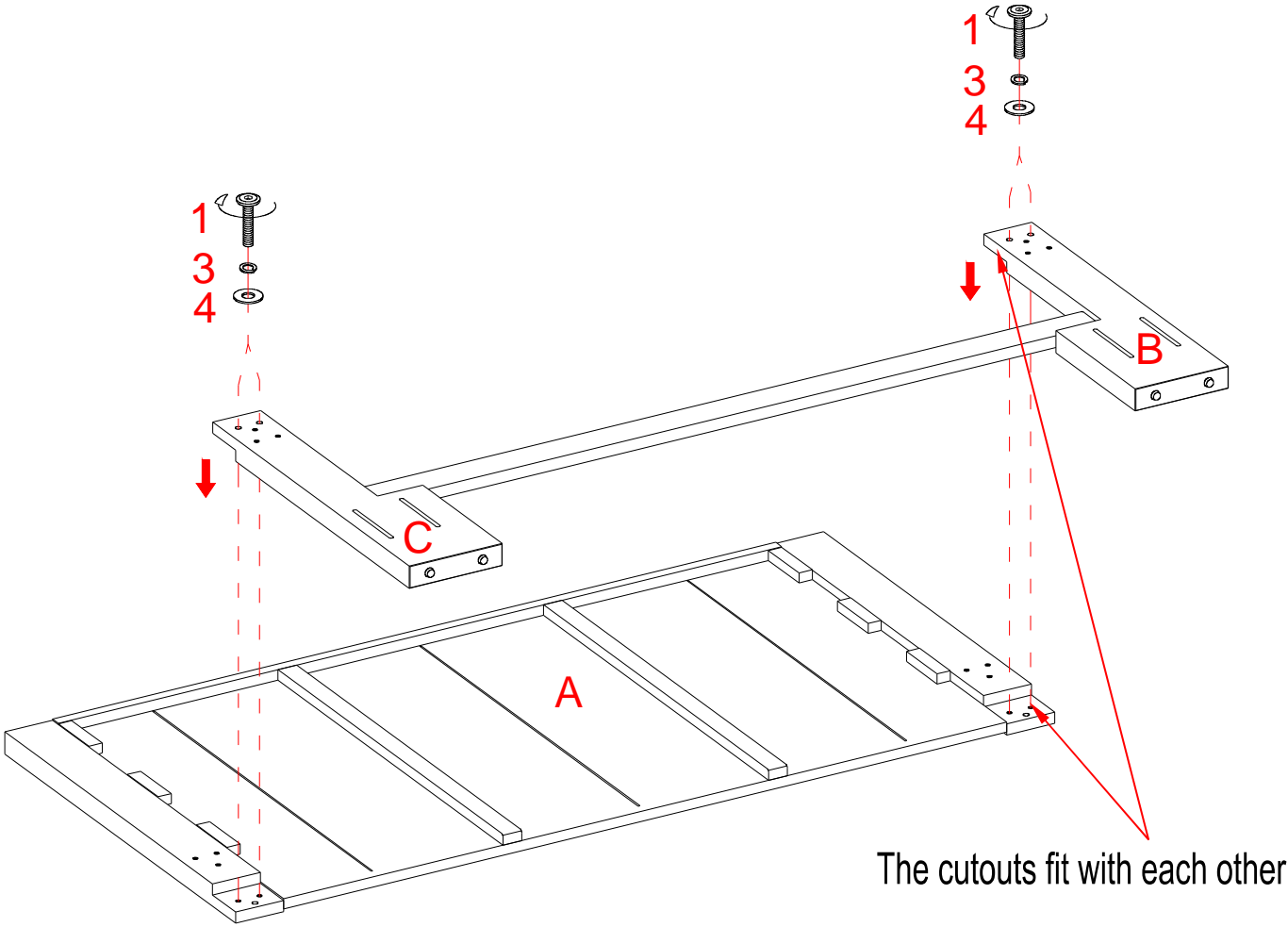

5. Attach the Legs (B and C) to the cutout of the Headboard (A) with four 1-3/8" Bolts (1) and four Washers (3 and 4).

Assembly Instructions

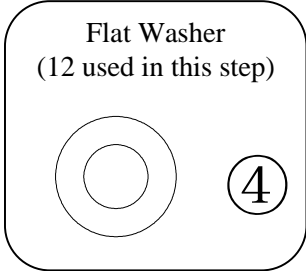
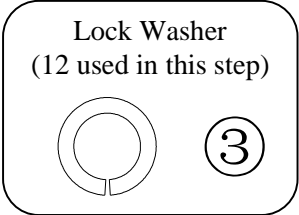
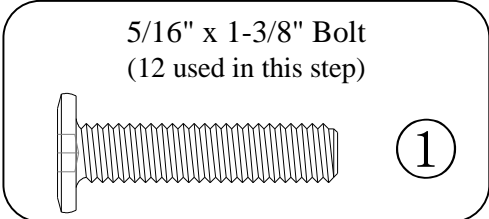
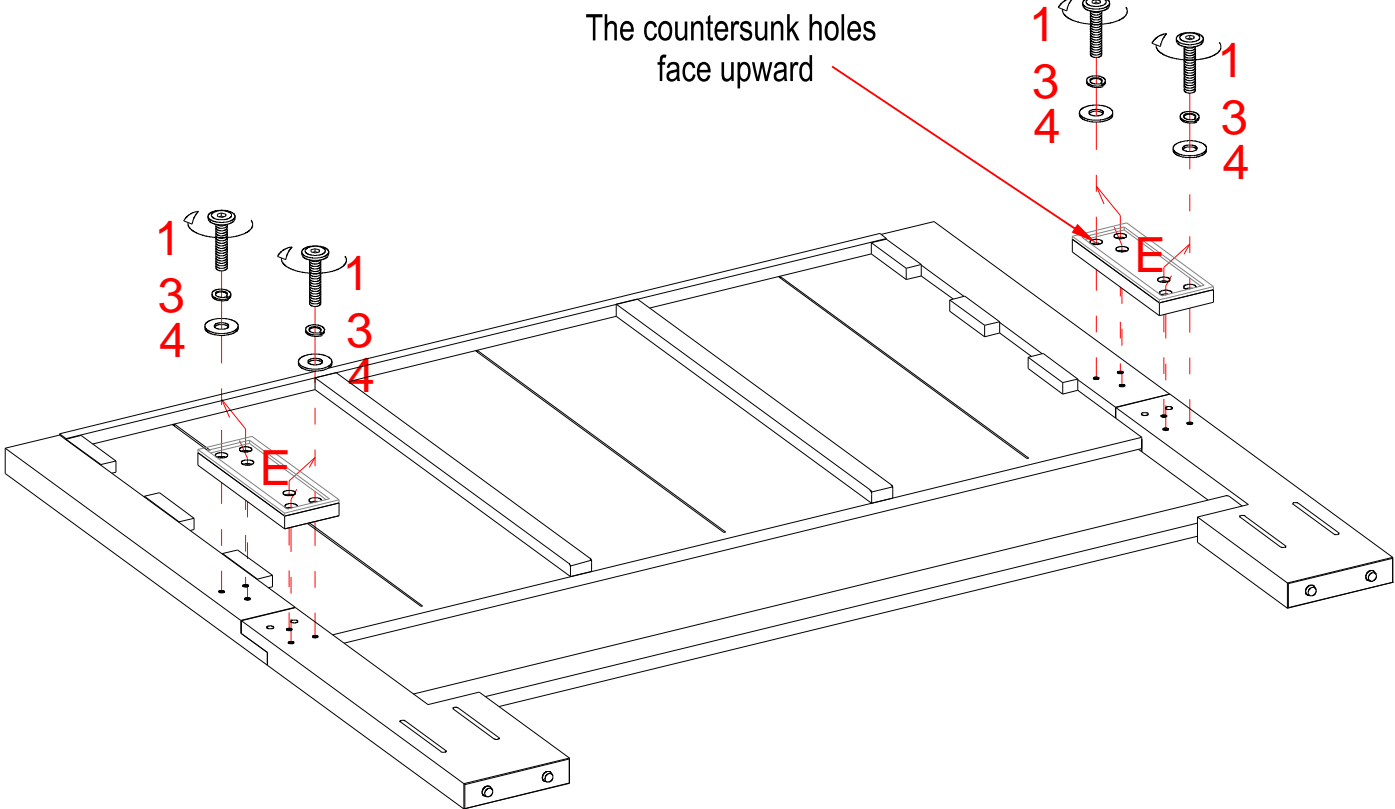

6. Fasten two Back Supports (E) to the joints where the Legs (B and C) meet with the Headboard (A) using twelve 1-3/8" Bolts (1) and twelve Washers (3 and 4).

Assembly Instructions

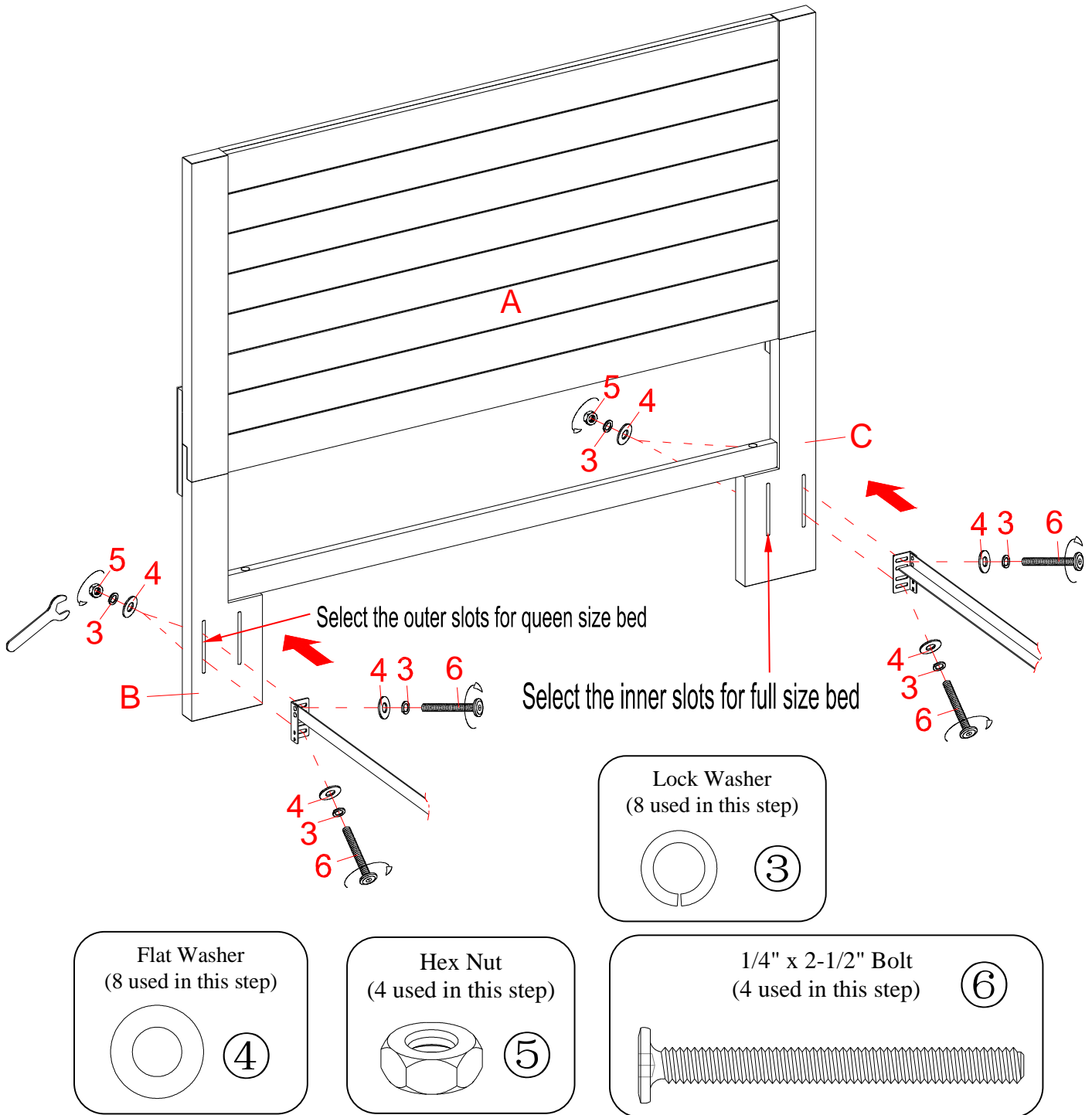

7. With assistance, stand the Headboard (A) upright and position it near the final installation location.
8. Align and attach the metal bed frame (sold separately) to the Left and Right Legs (B and C), depending on the mattress size that you own. For the queen size bed, select the outer mounting slots. For the full size bed, select the inner mounting slots.
9. Insert the 2-1/2" Bolts (6) with the Washers (3 and 4) through the end brackets of the metal bed frame and the mounting slots on the Legs (B and C). At the back of both Legs, fit the Flat Washer (4), Lock Washer (3) and the Hex Nut (5) onto each 2-1/2" Bolt (6). Securely tighten the nuts with the provided Open Wrench and Hex Wrench.

Care and Maintenance

- Use a soft, clean cloth that will not scratch the surface when dusting.
- Use of furniture polish is not necessary. Should you choose to use polish, test first in an inconspicuous area.
- Using solvents of any kind on your furniture may damage your furniture's finish.
- Never use water to clean your furniture as it may cause damage to the finish.
- Always use coasters under beverage glasses and flowerpots.
- Liquid spills should be removed immediately. Using a soft, clean cloth, blot the spill gently. Avoid rubbing.
- Always use protective pads under hot dishes and plates. Heat can cause chemical changes that may create spotting within the furniture finish.
- Stains or marks from crayons or ink markers will be difficult to remove.
- In the event that your furniture is stained or otherwise damaged during use, we recommend that you call a professional to repair your furniture.
- Check bolts/screws periodically and tighten them if necessary.

Further Advice about Wood Furniture Care

It is best to keep your furniture in a climate-controlled environment. Extreme temperature and humidity changes can cause fading, warping, shrinking and splitting of wood. It is advised to keep furniture away from direct sunlight as sun may damage the finish.

Proper care and cleaning at home will extend the life of your purchase. Following these important and helpful tips will enhance your furniture as it ages.

A touch-up pen has been provided to repair any small nicks or scratches that may occur during assembly or shipping.

We hope you enjoy your purchase for many years.
Thank you for your purchase!

QUALITY GUARANTEE

We are confident that you will be delighted with your Whalen Furniture purchase.

Should this product be defective in workmanship or materials or fail under normal use, we will repair or replace it for up to one (1) year from date of purchase. Every Whalen Furniture product is designed to meet your highest expectations. We guarantee that you will immediately see the value of our fine furniture.

This warranty gives you specific legal rights and you may also have other rights which vary from State to State.

Customer Service: 866-942-5362

8:30 a.m. - 4:30 p.m., PST, Monday to Friday

www.whalenstyle.com

Cabecera Bryant

Serie # BH17-084-099-53

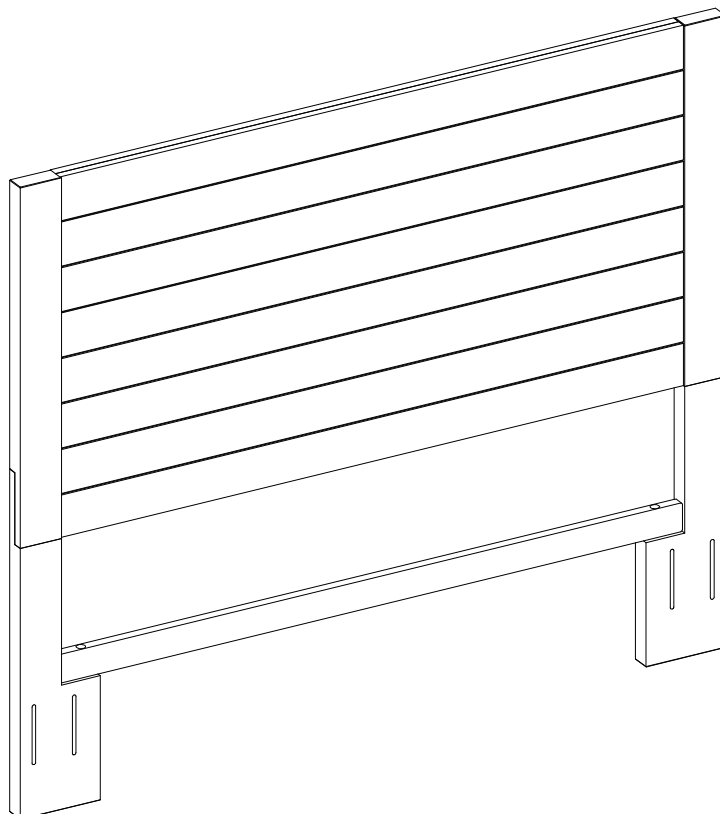

ENSAMBLE REQUERIDO POR ADULTO

Si tienen alguna pregunta acerca del ensamble o si alguna parte está faltante, no retorne este producto a la tienda donde lo compró. Por favor llame a nuestro departamento de ayuda al cliente teniendo su instructivo y lista de partes para proveer el modelo, nombre de parte o el número de fábrica:

866-942-5362

Hora Estándar del Pacífico: 8:30 a.m. - 4:30 p.m., de Lunes a Viernes
O visite nuestra página de Internet 24 horas al día, 7 días a la semana para asistencia

www.whalenstyle.com

O mande un correo electrónico a **parts@whalenfurniture.com**

**ESTE INSTRUCTIVO CONTIENE INFORMACION IMPORTANTE DE SEGURIDAD.
POR FAVOR LEA Y MANTENGA PARA USO FUTURO.**

Fecha 2017-05-18 Rev. 0001-A Fábrica: ZHIVIE

Lista de partes y material de ferretería

Por favor lea completamente las instrucciones y verifique que estén todas las partes antes de iniciar el ensamblado.

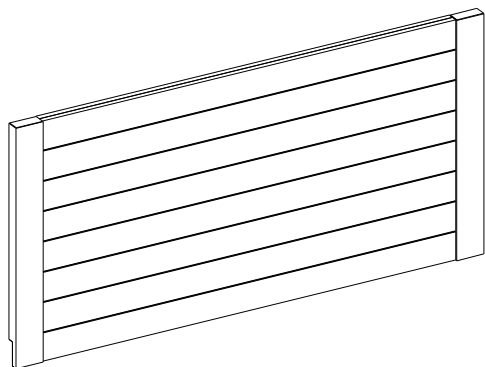

A- Cabecera (Cant. 1)

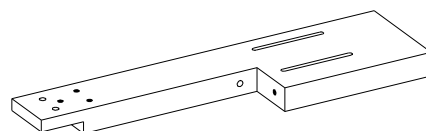

B- Pata izquierda (Cant. 1)

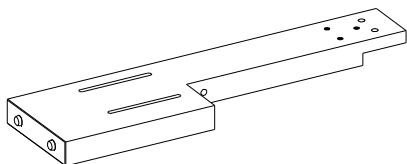

C- Pata derecha (Cant. 1)

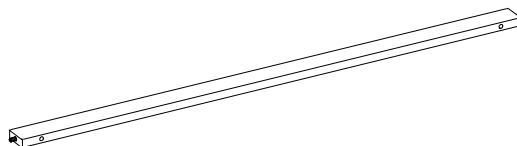

D- Soporte inferior (Cant. 1)

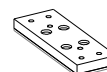

E- Soporte posterior (2)

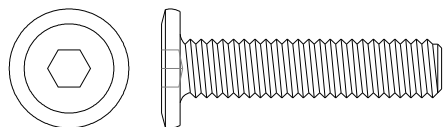

(1) Perno de 5/16" x 1-3/8" (Cant. 16+1 extra)
(4 piezas previamente instalada)

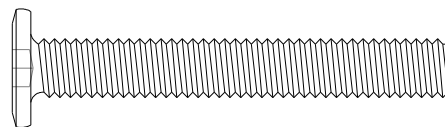

(2) Perno de 5/16" x 2-1/4" (Cant. 2+1 extra)

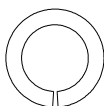

(3) Arandela de presión (Cant. 26+1 extra)
(4 piezas previamente instalada)

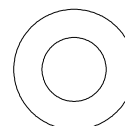

(4) Arandela plana (Cant. 26+1 extra)
(4 piezas previamente instalada)

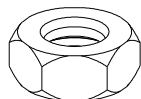

(5) Tuerca hexagonal (Cant. 4+1 extra)

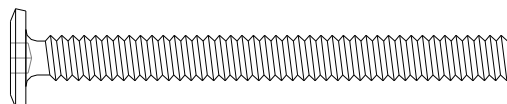

(6) Perno de 1/4" x 2-1/2" (Cant. 4+1 extra)



Llave española (Cant. 1)



Llave hexagonal (Cant. 1)

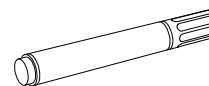

Plumón de retoque (Cant. 1)

Herramientas requeridas: Llave española y llave hexagonal (proveída).

Instructivo de ensamble

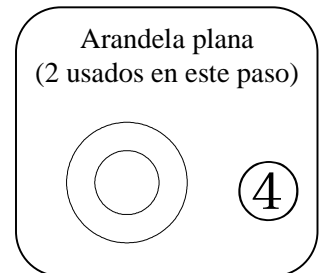
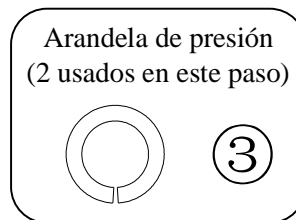
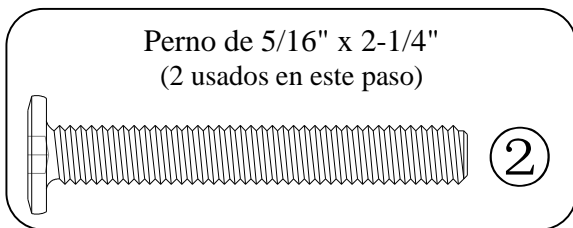
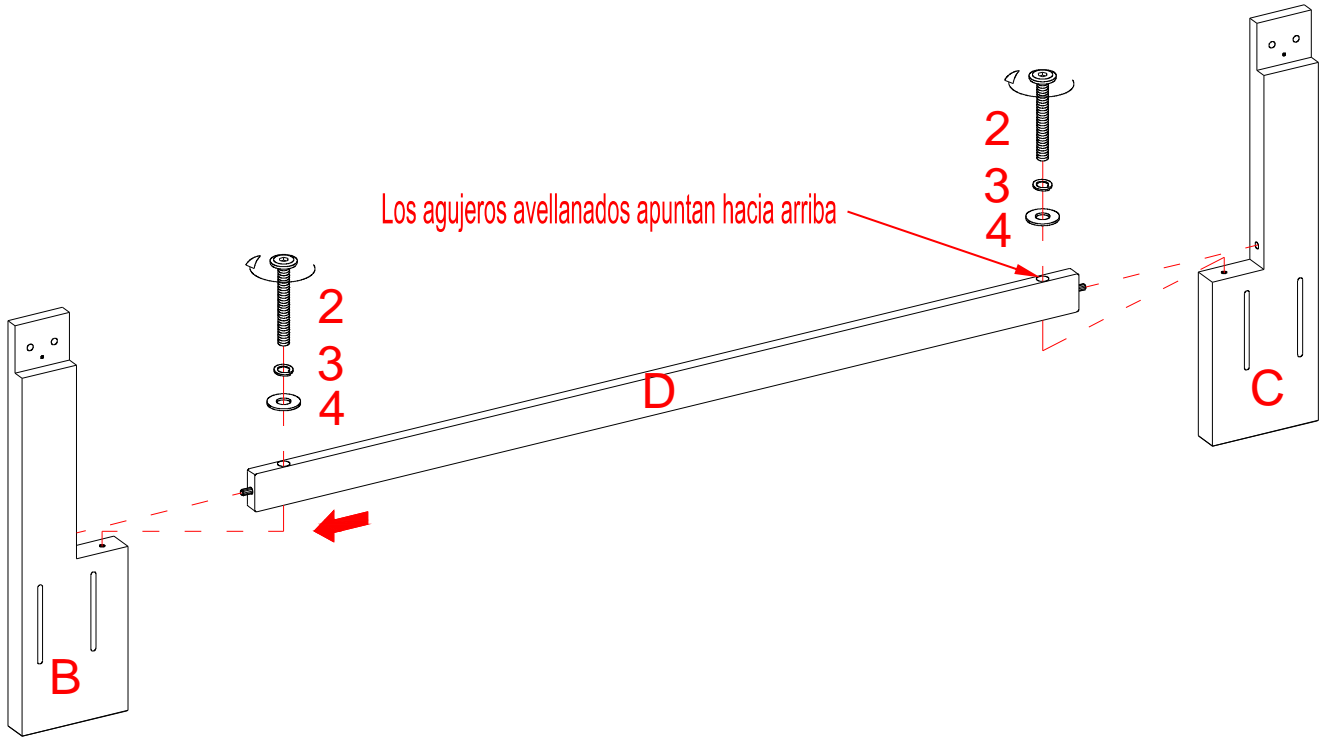

1. Desempacar la unidad y confirmar que se tiene todo el material de ferretería y partes requeridas.
2. Sujetar el soporte inferior (D) entre las patas (B y C) con 2 pernos de 2-1/4" (2) y 2 arandelas (3 y 4).

Instructivo de ensamble

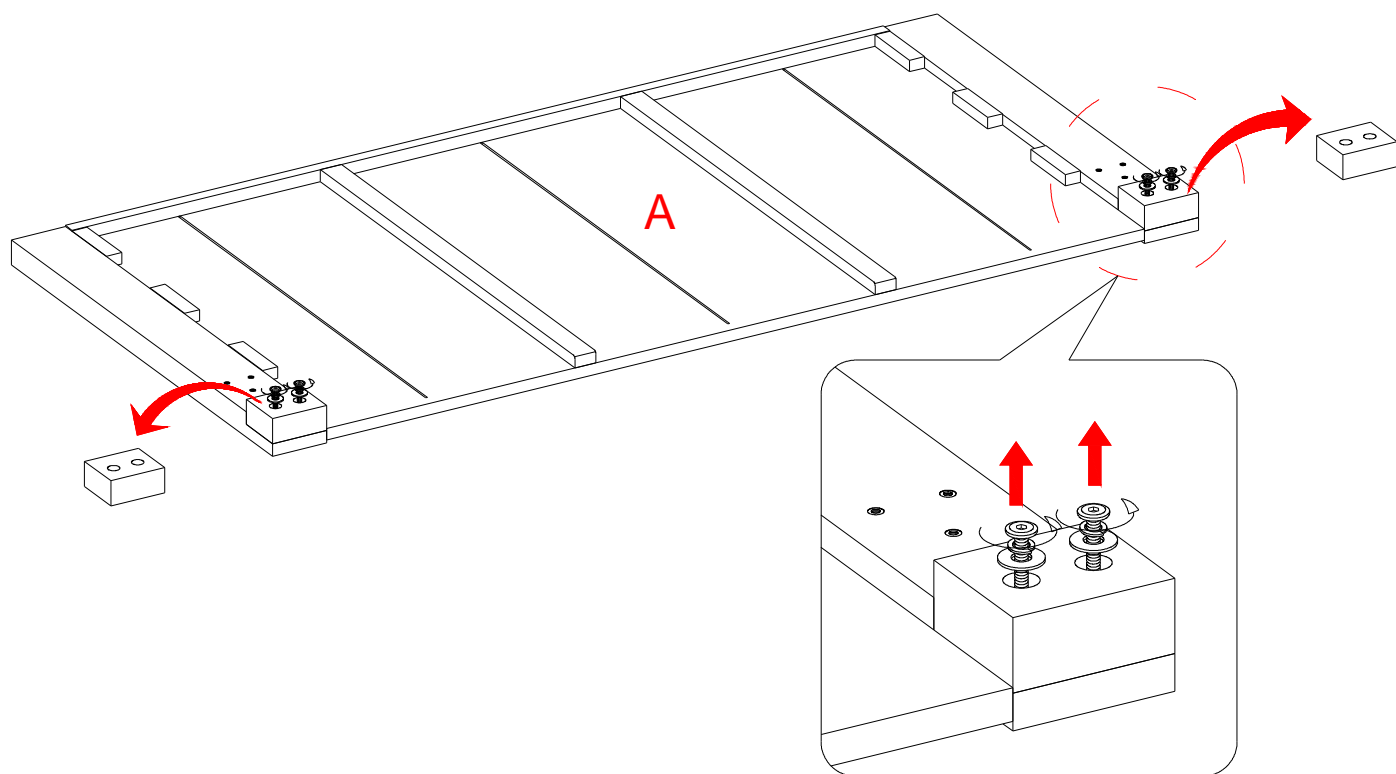

3. Posicionar la cabecera (A) y poner la cara frontal abajo en una superficie nivelada y protegida.
4. Remover los bloques de madera adicionales de la cabecera (A) quitando los 4 pernos de 1-3/8" (1) y cuatro arandelas (3 y 4). Guarde los pernos y arandelas para uso posterior. Los bloques de madera son utilizados solo para envíos. Después de quitar, puede tirarlos.

Instructivo de ensamble

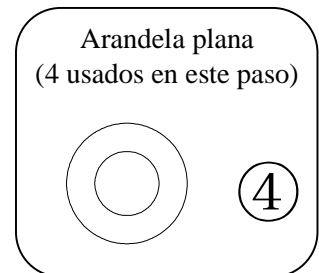
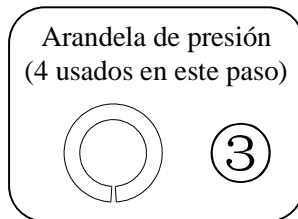
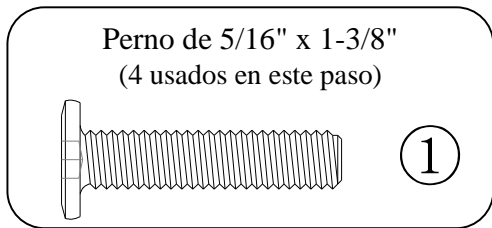
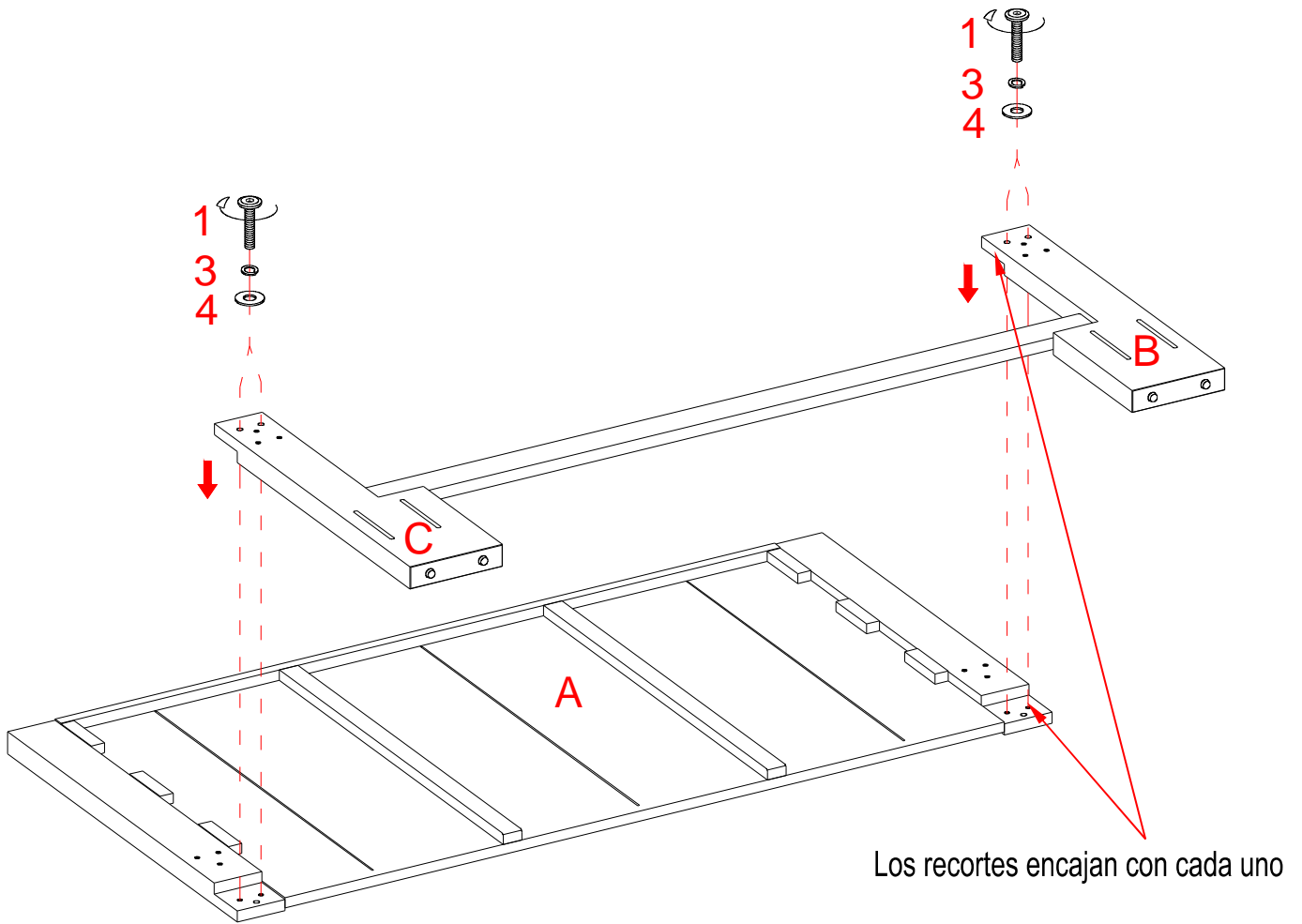

5. Sujetar las patas (B y C) al recorte de la cabecera (A) con 4 pernos de 1-3/8" (1) y 4 arandelas (3 y 4).

Instructivo de ensamble

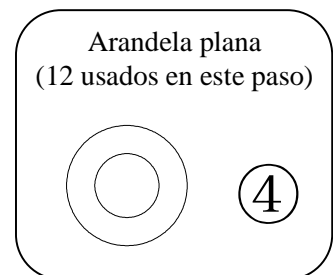
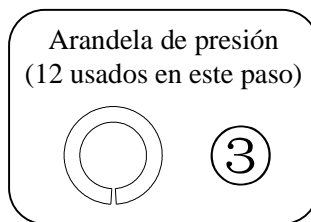
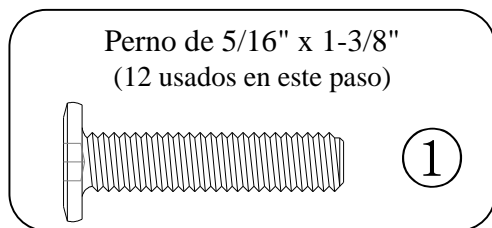
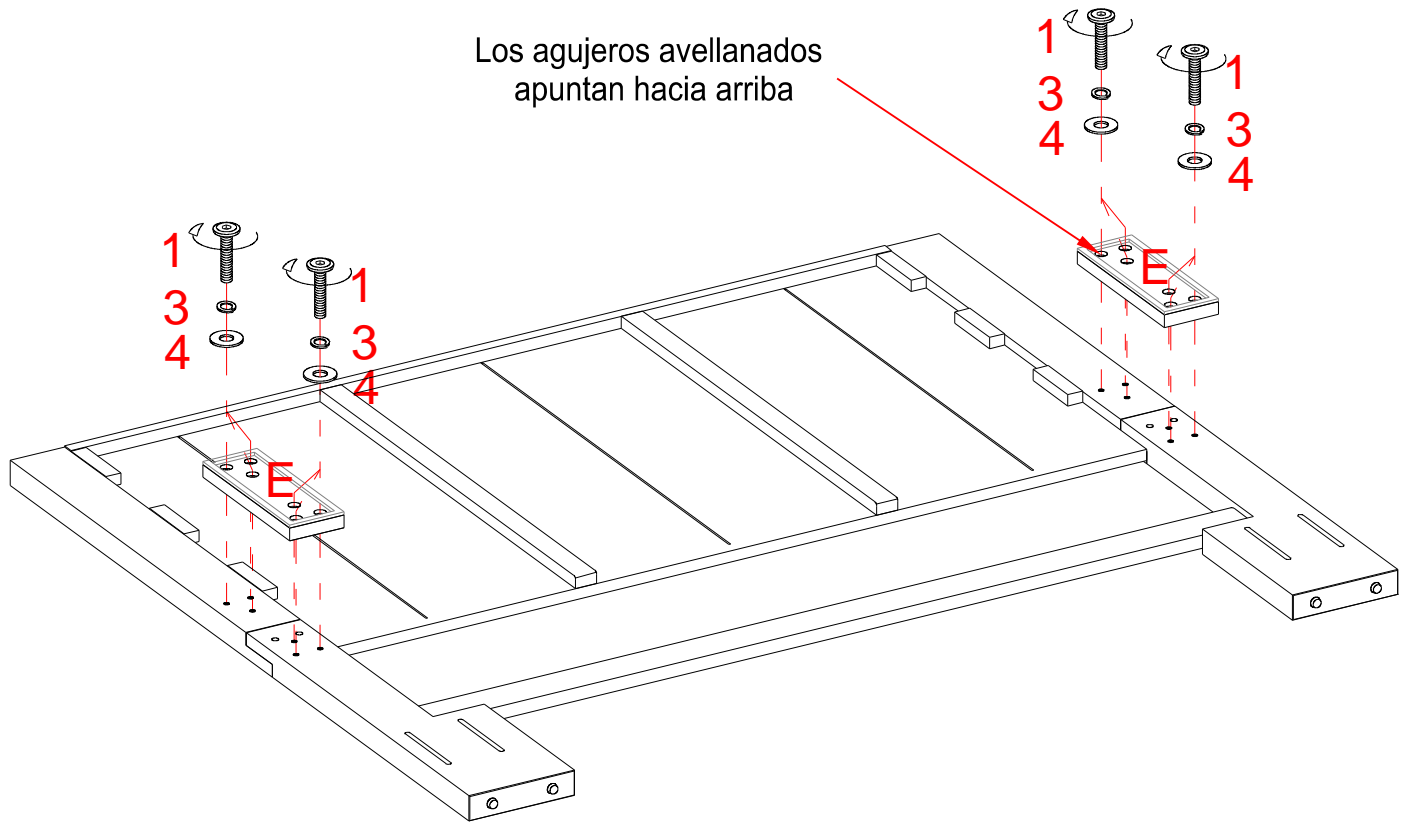

6. Apriete dos soportes posteriores (E) a las juntas donde las patas (B y C) se reúne con la cabecera (A) con 12 pernos de 1-3/8" (1) y 12 arandelas (3 y 4).

Instructivo de ensamble

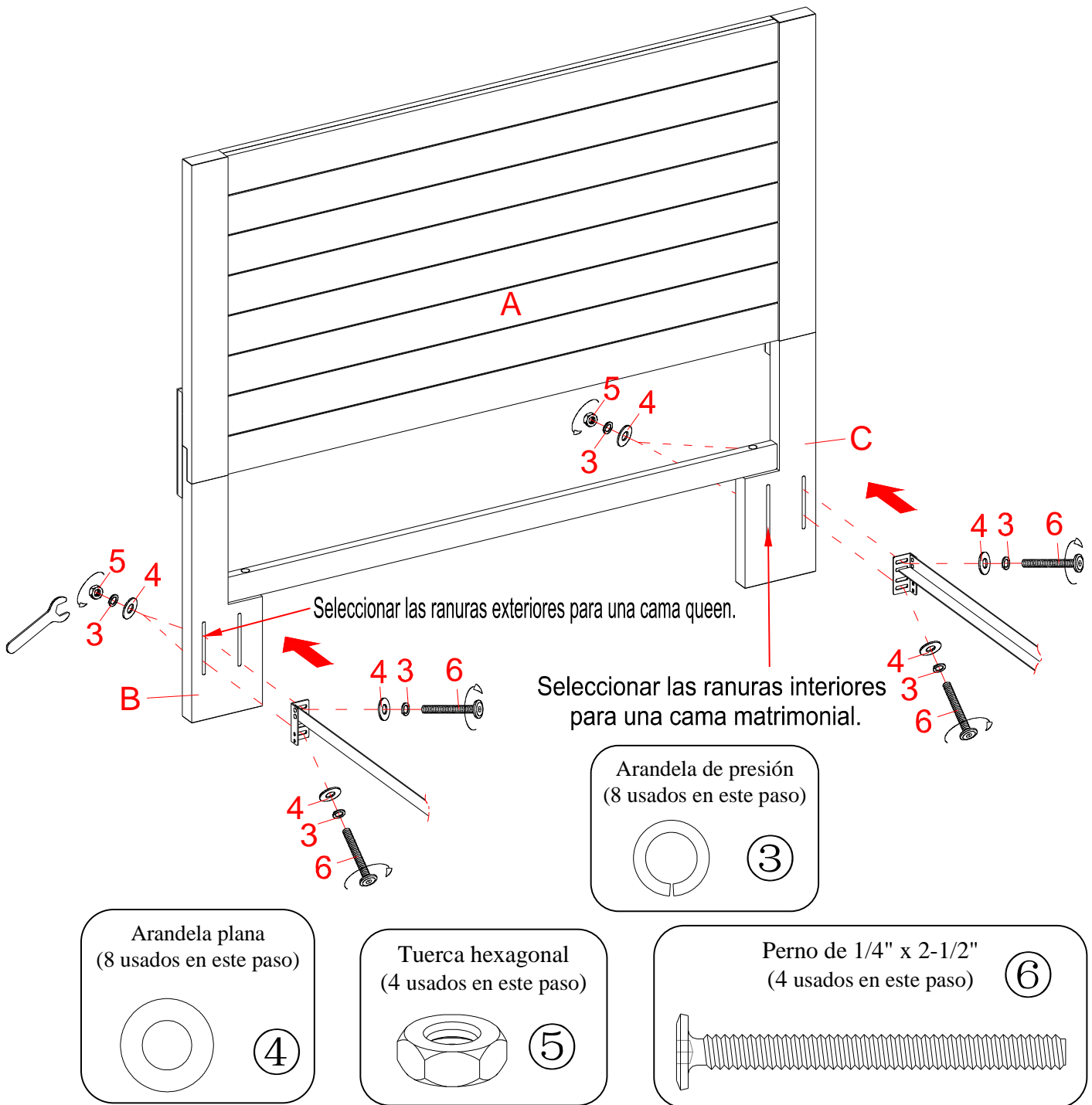

7. Con asistencia, poner la cabecera (A) en posición vertical y posicionar cerca del lugar de instalación final.
8. Alinear y adjuntar el marco de metal de la cama (vendido por separado) a las patas izquierda y derecha (B y C), dependiendo del tamaño de el colchón. Para una cama queen, seleccionar las ranuras de montaje exteriores. Para una cama matrimonial, seleccionar las ranuras de montaje interiores.
9. Insertar los pernos de 2-1/2" (6) con las arandelas (3 y 4) a través de los soportes finales de el marco de metal de la cama y de las ranuras de montaje en las patas (B y C). En la parte posterior de ambas patas, meter una arandela plana (4), una arandela de presión (3) y una tuerca hexagonal (5) en cada perno de 2-1/2" (6). Apretar las tuercas con la llave española.

Mantenimiento y Cuidados

- Use una toalla suave y limpia para evitar daños y rayaduras.
- Uso de cera para pulir muebles no es necesario. Si desea usar cera, pruebela en un área que no sea visible para revisar su funcionamiento.
- Usar solventes de cualquier tipo puede dañar el acabado del mueble.
- Nunca use agua para limpiar la unidad, ya que le puede dañar el acabado.
- Siempre utilice protección para vasos cuando los ponga sobre la unidad.
- Líquidos derramados deben limpiarse inmediatamente, con una toalla suave evitando tallar.
- Siempre utilizar protectores en caso de poner cosas calientes. El calor puede provocar una reacción química en el acabado y dañarlo.
- En caso que su unidad sea manchada durante el uso le recomendamos hablar a un profesional para que le ayude.
- Revisar los tornillos periódicamente y apretar en caso necesario.

Más recomendaciones para el cuidado de su Mueble

Es mejor mantener la unidad en una área de clima controlado. Temperatura extrema y cambios de humedad pueden causar cambios como partes pandas, molduras que se contraigan o que la madera se raje. Es recomendable mantener la unidad lejos del sol directo ya que puede dañar el acabado.

Cuidados adecuados y limpieza pueden extender la vida útil de su unidad. Siga estas recomendaciones y mantendra su mueble en buenas condiciones de uso por muchos años.

Un plumón de retoque es proveído en caso de pequeñas raspaduras o golpes que sucedan durante el ensamble o envío.

Esperamos que disfrute su mueble por muchos años.
Gracias por su compra!

GARANTÍA DE CALIDAD

Nosotros estamos seguros que usted se encontrará feliz con la compra de esté producto de Whalen Furniture.

Si esté producto tiene algun defecto de ensamble o material, o si tiene alguna falla en uso normal, nosotros lo repararemos o lo re-emplazaremos hasta por un año a partir de la fecha de compra. Todo producto de Whalen Furniture es diseñado para alcanzar sus expectativas más altas. Nosotros le garantizamos que inmediatamente podrá ver el valor de nuestra mercancía de la más alta calidad.

Está garantía le proporciona derechos legales específicos y talvez tenga otros derechos que varían de estado a estado.

Servicio al cliente: 866-942-5362

Hora Estándar del Pacífico: 8:30 a.m. - 4:30 p.m., de Lunes a Viernes

www.whalenstyle.com